

51540ASY

EQUIPTO

MODULAR DRAWER & OPEN LEG WORKCENTER ASSEMBLY INSTRUCTIONS

READ INSTRUCTIONS BEFORE ASSEMBLING

51540ASY

MODULAR DRAWER & OPEN LEG WORKCENTER ASSEMBLY INSTRUCTIONS

A. ASSEMBLY PROCEDURE:

1. INSTALL SHELF SUPPORT ANGLE AS SHOWN IN STEP 1.
2. MODULAR CABINET RISER INSTALLATION AS SHOWN IN STEP 2.
3. ASSEMBLE HALF SHELF AS SHOWN IN STEP 3. DO NOT TIGHTEN THE BOLTS UNTIL THE WORKCENTER IS COMPLETELY ASSEMBLED
4. FASTEN STEEL TOP IN PLACE AS SHOWN IN STEP 4. TIGHTEN ALL FASTENERS SECURELY.
5. ASSEMBLE WOOD TOP IN PLACE AS SHOWN IN STEP 5

B. LIST OF WORKCENTER TOP MATERIALS AVAILABLE

DIMENSIONS

34" HIGH
60", 72" OR 96" LONG
30" DEEP

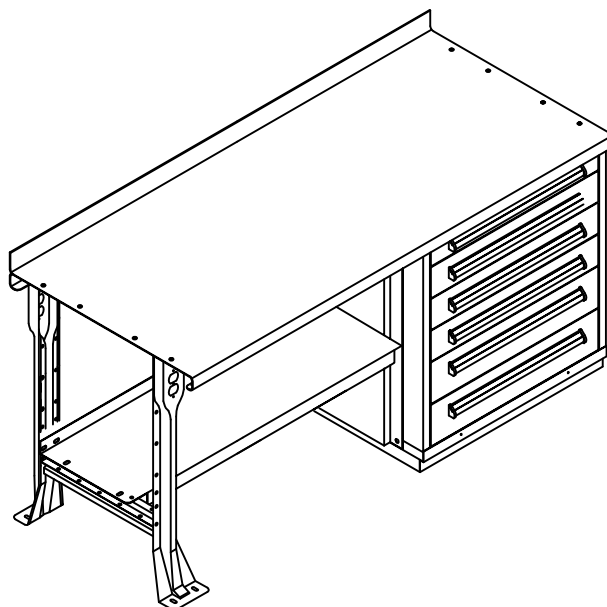

NOTE

MODULAR DRAWER CABINET
CAN BE ASSEMBLED IN
THE RIGHT OR LEFT HAND
SIDE OF WORKCENTER

A. ASSEMBLY PROCEDURE

Step

1

SHELF SUPPORT ANGLES INSTALLATION

NOTE

USE THE UPPER ROW OF HOLES IN SHELF SUPPORT ANGLE.

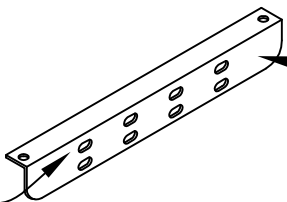

#9504 SHELF SUPPORT ANGLE

#13154 SCREW

NOTE

USE THE OUTSIDE HOLES IN ANGLE TO BOLT IT IN RISER AS SHOWN.

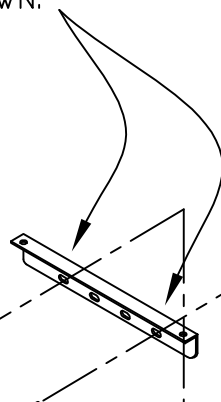

#7423 RISER FOR 34" BENCH HEIGHT

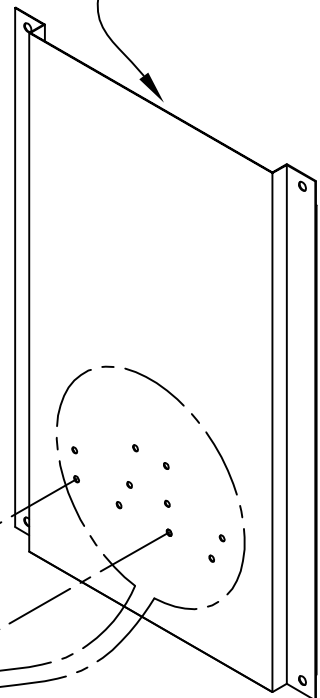

NOTE

FOR 34" HIGH WORKCENTER

IF YOU HAVE THE CABINET IN THE RIGHT HAND SIDE OF THE WORKCENTER, USE THE 3-3' PAIR OF HOLES TO BOLT THE ANGLE

IF YOU HAVE THE CABINET IN THE LEFT HAND SIDE OF THE WORKCENTER, USE THE 5-5' PAIR OF HOLES TO BOLT THE ANGLE.

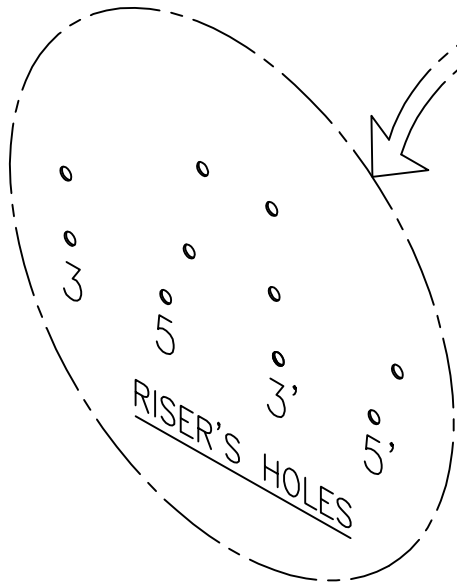

NOTE

TIGHTEN ALL FASTENERS SECURELY

- #13154 TRUSS HD MACH SCREW
5/16" X 3/4"
- #13051 TWIN WHIZZ LOCKNUT
5/16" - 18
(2 PER RISER)

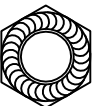
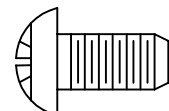

FULL SCALE

Step

2

CABINET RISER INSTALLATION

NOTE

INSTALL RISER ON THE LEFT HAND OF THE CABINET BENCH AS SHOWN.. INSTALL RISER ON THE RIGHT HAND OF CABINET IF YOU HAVE A LEFT HAND CABINET BENCH

MODULAR
CABINET

13154 SCREW

NOTE

TIGHTEN ALL FASTENERS
SECURELY

7423 RISER
FOR 34" HIGH WORKCENTER

#13154 TRUSS HD MACH SCREW
5/16" X 3/4"
#13051 TWIN WHIZZ LOCKNUT
5/16" - 18
(4 PER RISER)

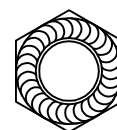
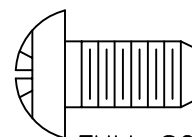

FULL SCALE

PATENT PENDING

Step

3

HALF SHELF ASSEMBLY

NOTE

USE OUTSIDE HOLES
IN SHELF

NOTE

USE INSIDE HOLES
IN SHELF

#13154 SCREW

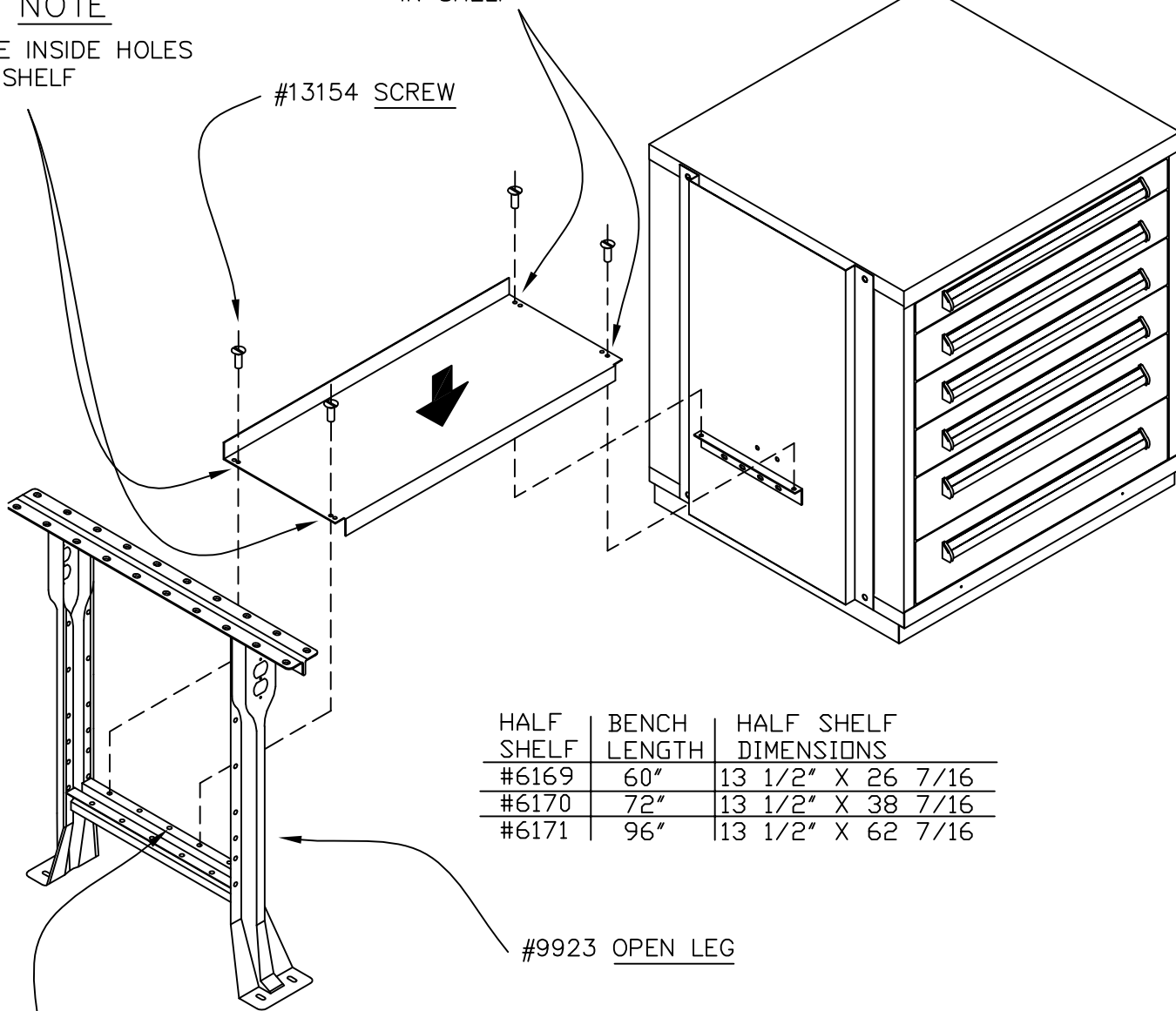

NOTE

USE INSIDE ROW OF HOLES
IN LEG TO BOLT THE SHELF.

NOTE

DO NOT TIGHTEN THE BOLTS
UNTILL THE WORKCENTER IS
COMPLETELY ASSEMBLED.

#13154 TRUSS HD MACH SCREW
5/16" X 3/4"

#13051 TWIN WHIZZ LOCKNUT
5/16" - 18
(4 PER SHELF)

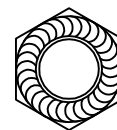
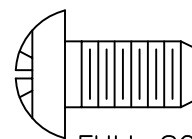

FULL SCALE

Step 4 STEEL TOP ASSEMBLY

4

a. SHIM ANGLE INSTALLATION

END RAILS (16 GA.)

LEFT HAND	SIZE	RIGHT HAND
#7417L	30" STEEL	#7417R

NOTE

OPTIONAL END RAILS AND AERIAL SHELF MUST BE ATTACHED AT THIS POINT. IF YOU HAVE AN AERIAL SHELF SEE THOSE INSTALLATION INSTRUCTIONS.

NOTE

INSTALL ONE SHIM ANGLE TO THE RIGHT HAND END OF THE TOP IF YOU HAVE THE CABINET TO THE RIGHT. INSTALL ONE SHIM ANGLE TO THE LEFT HAND END OF THE TOP IF YOU HAVE THE CABINET TO THE LEFT. THE NAME "EQUIPTO" IS TO BE TOWARD THE FRONT OF THE BENCH.

FLANGE UP

FLANGE DOWN

#7433 L.H. SHIM ANGLE

#7433 R.H. SHIM ANGLE

NOTE

USE OUTSIDE HOLES IN SHIM ANGLE

#13154 SCREW

#13165 SCREW

#13165 FLAT HEAD BOLT 1/4" x 1"

#13131 HEX NUT 1/4"

(4 PER SHIM)

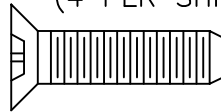

FULL SCALE

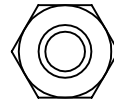

#13154 TRUSS HD MACH SCREW
5/16" x 3/4"

#13051 TWIN WHIZZ LOCKNUT
5/16" - 18
(1 PER END RAIL)

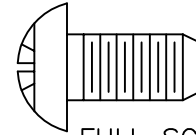

FULL SCALE



b. STEEL TOP INSTALLATION

FOR HARDBOARD ON STEEL,
AFTER TOP IS ATTACHED
INSERT PLUGS AS SHOWN.

#13153 SCREW

#13165 SCREW

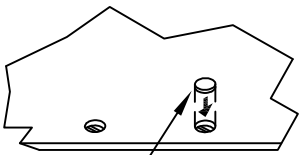

#10206-3/4" DIA. PLUG

#9923 OPEN LEG

NOTE

TIGHTEN ALL FASTENERS SECURELY.

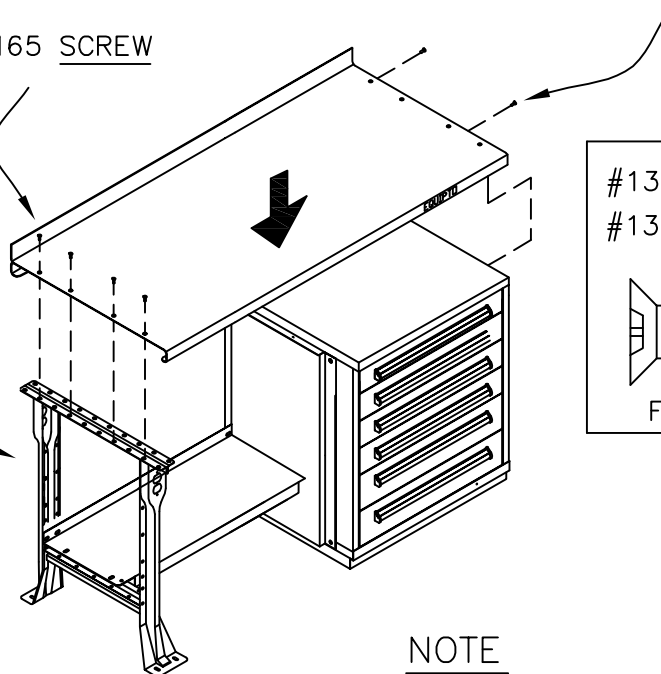

#13165 FLAT HEAD BOLT 1/4" x 1"

#13131 HEX NUT 1/4"

(4 PER LEG)

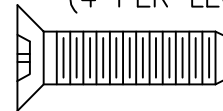

FULL SCALE

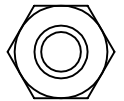

#13153 HEX HEAD CAP SCREW

6/16 - 18 x 3/4"

(2 PER CABINET)

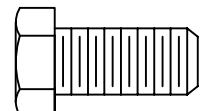

FULL SCALE

NOTE

THE NAME "EQUIPTO" IS TO BE TOWARD THE FRONT OF THE BENCH.

Step 5 WOOD TOP ASSEMBLY

5

a. SHIM ANGLE INSTALLATION

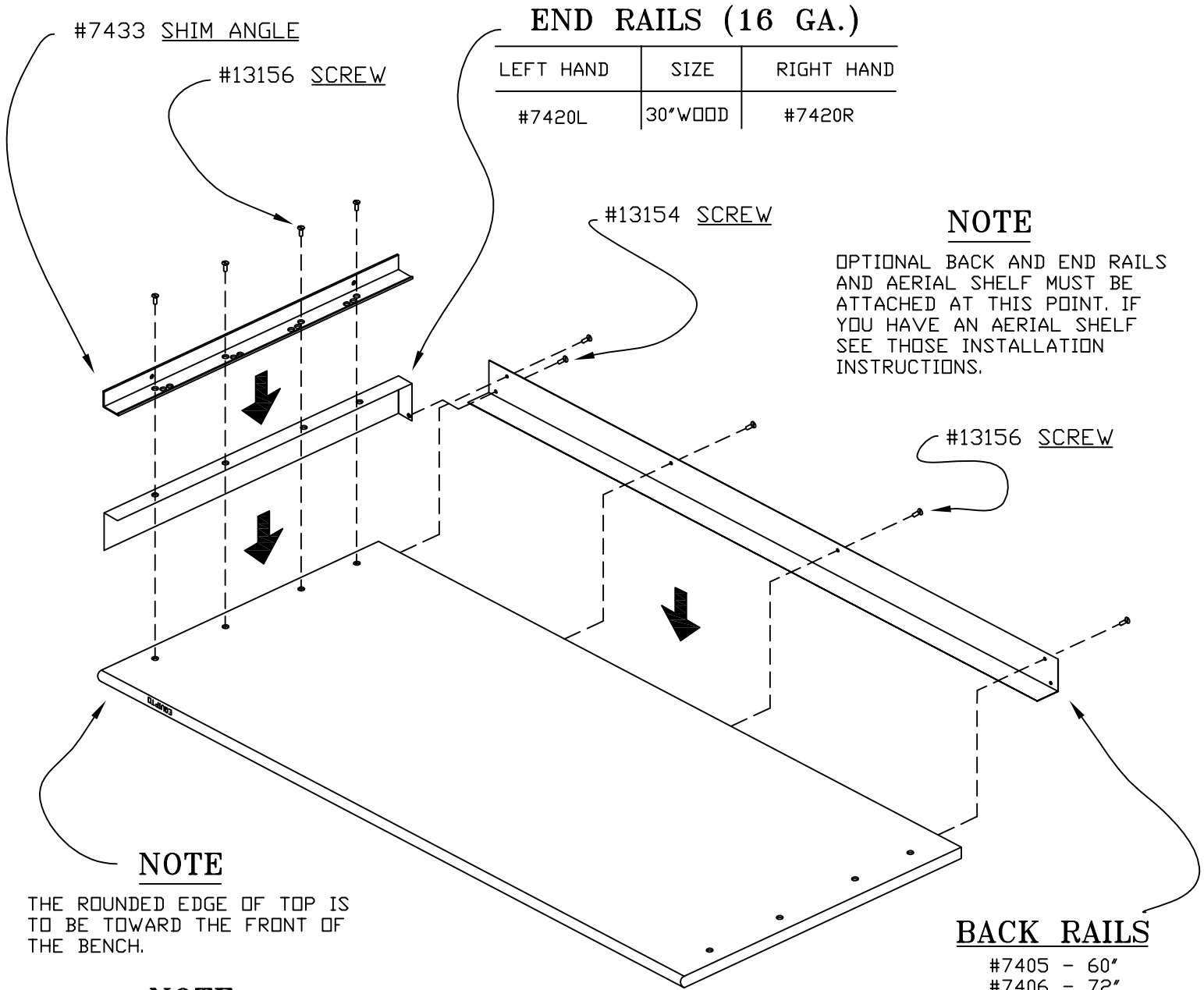

END RAILS (16 GA.)

LEFT HAND	SIZE	RIGHT HAND
#7420L	30" WOOD	#7420R

NOTE

OPTIONAL BACK AND END RAILS AND AERIAL SHELF MUST BE ATTACHED AT THIS POINT. IF YOU HAVE AN AERIAL SHELF SEE THOSE INSTALLATION INSTRUCTIONS.

NOTE

THE ROUNDED EDGE OF TOP IS TO BE TOWARD THE FRONT OF THE BENCH.

NOTE

TURN THE WOOD TOP UPSIDED DOWN. AFTER THE BACK RAIL IS IN POSITION AND FASTENED TO THE REAR FLANGES OF THE END RAILS, DRILL 3/16" DIA. X 1" DEEP PILOT HOLES IN THE REAR EDGE OF THE WOOD TOP.

NOTE

INSTALL ONE SHIM ANGLE TO THE RIGHT (LEFT) END OF THE TOP IF YOU HAVE A RIGHT (LEFT) HAND CABINET BENCH.

BACK RAILS

- #7405 - 60"
- #7406 - 72"
- #7411 - 96"

#13156 HEX WASHER HEAD TAPPING SCREW
1/4" - 14 X 1"
(4 PER SHIM ANGLE)
(4 PER BACK RAIL)

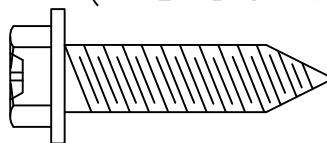

FULL SCALE

#13154 TRUSS HD MACH SCREW
5/16" X 3/4"

#13051 TWIN WHIZZ LOCKNUT
5/16" - 18
(1 PER END RAIL)

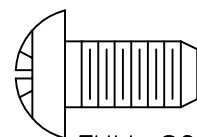

FULL SCALE



Step 5 WOOD TOP ASSEMBLY

5

(CONTINATION)

b. WOOD TOP INSTALLATION

NOTE

TIGHTEN ALL FASTENERS SECURELY

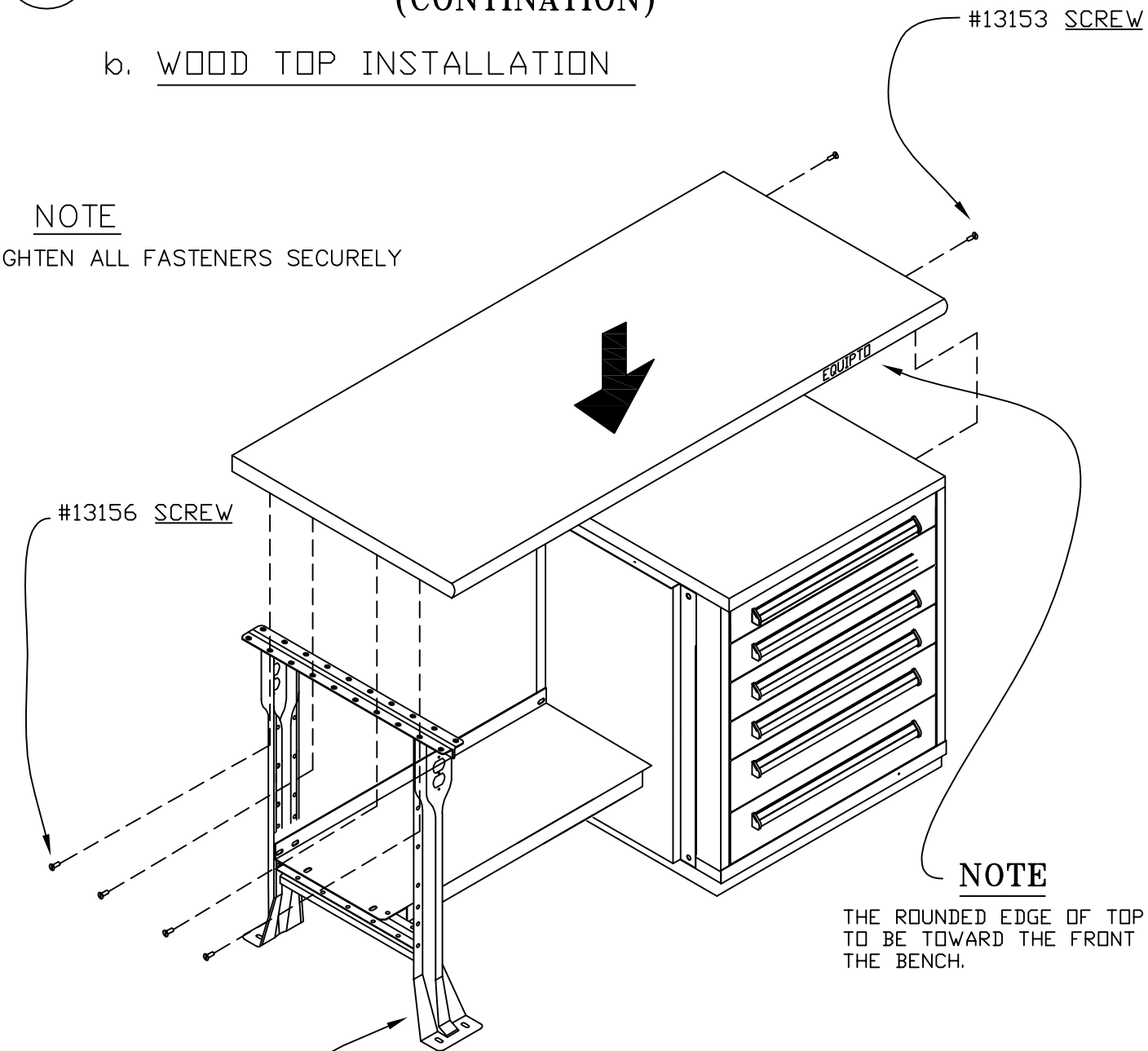

NOTE

THE ROUNDED EDGE OF TOP IS TO BE TOWARD THE FRONT OF THE BENCH.

#13156 HEX WASHER HEAD TAPPING SCREW
1/4" -14 X 1"
(4 PER LEG)

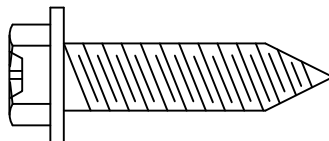

FULL SCALE

#13153 HEX HEAD CAP SCREW
6/16 -18 X 3/4"
(2 PER CABINET)

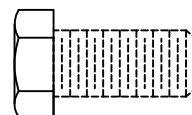

FULL SCALE

B

BENCH TOP MATERIALS AVAILABLE

1

MATERIALS FOR STEEL TOP

<u>STEEL (12 GA.)</u>			<u>HARDBOARD ON STEEL (12 GA.)</u>		
<u>FLANGE DOWN</u>	<u>SIZE</u>	<u>FLANGE UP</u>	<u>FLANGE DOWN</u>	<u>SIZE</u>	<u>FLANGE UP</u>
#11480D	30" X 60"	#11480	#11498D	30" X 60"	#11498
#11481D	30" X 72"	#11481	#11499D	30" X 72"	#11499
#11482D	30" X 96"	#11482	#11500D	30" X 96"	#11500

2

MATERIALS FOR WOOD TOP

BONDED WOOD 1-3/4" THICK

#12348D 30" X 60"
#12349D 30" X 72"
#12378D 30" X 96"

CONDUCTIVE 1-1/4" THICK

#12305D 30" X 60"
#12306D 30" X 72"
#12380D 30" X 96"

CONDUCTIVE 1-1/4" THICK

#12339D 30" X 60"
#12340D 30" X 72"
#12376D 30" X 96"

NOTE

SEE ADDITIONAL ACCESSORY INSTRUCTIONS:

#51910ASY WORKBENCH DRAWERS

#42227 AERIAL SHELF & PICK RACK KITS

#42960A-B PRODUCTION BOOSTER AERIAL SHELF